

Review article

Pulse and pulse reverse plating—Conceptual, advantages and applications

M.S. Chandrasekar, Malathy Pushpavanam*

Central Electrochemical Research Institute, Karaikudi 630006, TN, India

Received 20 July 2007; received in revised form 19 November 2007; accepted 19 November 2007

Available online 15 January 2008

Abstract

A review on pulse and pulse reverse techniques for electrodeposition have been attempted. Pulse electrodeposition (PED) of some metals and alloys are reported. The effects of mass, transport, electrical double layer pulse parameters and current distribution on surface roughness and morphology are presented. Applications, advantages and disadvantages of PC and PRC techniques are discussed along with theoretical aspects and mechanism.

© 2007 Elsevier Ltd. All rights reserved.

Keywords: Pulse current (PC) electrodeposition; Pulse reverse current (PRC); Individual metals and their alloys; Composites and semiconductor; Applications

Contents

1. Introduction	3314
2. Types of pulse waveform	3314
3. Concepts of pulse and pulse reverse techniques	3314
4. Advantage of pulse and pulse reverse techniques	3316
5. Pulse and pulse reverse current parameters	3316
6. Pulse electrodeposition—deciding factors	3316
6.1. Charging of the electrical double layer (EDL) at the metal–electrolyte interface	3316
6.2. Mass transport	3316
7. Pulse current and deposit properties	3316
8. Pulse current and duty cycle/frequency	3317
9. Pulse current and current distribution	3317
10. Pulse current and power consumption	3317
11. Pulse current and additives	3317
12. Pulse plating of alloys	3317
13. PC and PRC deposition of individual metals and alloys	3318
13.1. Chromium and its alloys	3318
13.2. Cobalt alloys	3318
13.3. Copper and its alloys	3318
13.4. Gold and its alloys	3318

Abbreviations: T_{ON} , Pulse ON-time (ms); T_{OFF} , Pulse OFF-time (ms); I_p , Pulse peak current density ($A\ dm^{-2}$); PC, Pulse current; PED, Pulse electrodeposition; PRC, Pulse reverse current; DC, Direct current; PCB, Printed circuit board; γ , Duty cycle; f , Frequency; T , Cycle time (or period) (ms); I_A , Average current density in PC ($A\ dm^{-2}$); \bar{I}_A , Average current in PRC ($A\ dm^{-2}$); I_C , Cathodic current density ($A\ dm^{-2}$); I_{AA} , Anodic current density ($A\ dm^{-2}$); T_C , Cathodic (forward) time (ms); I_F , Faradic current ($A\ dm^{-2}$); t_c , Charging time (ms); t_D , Discharging time (ms); I_L , Pulse limiting current density ($A\ dm^{-2}$); I_G , DC limiting current density ($A\ dm^{-2}$).

* Corresponding author. Tel.: +91 4565 227550–9; fax: +91 4565 227779/13.

E-mail address: malathypush@yahoo.com (M. Pushpavanam).

13.5. Nickel and its alloys	3318
13.6. Platinum	3319
13.7. Silver and its alloys	3319
13.8. Zinc and its alloys	3319
13.9. Composites	3319
13.10. Semiconductors	3319
14. Technological applications	3319
15. Disadvantages of pulse and pulse reverse techniques	3320
16. Conclusion	3320
Acknowledgement	3320
References	3320

1. Introduction

In pulse electrodeposition (PED) [1–3] the potential or current is alternated swiftly between two different values. This results in a series of pulses of equal amplitude, duration and polarity, separated by zero current. Each pulse consists of an ON-time (T_{ON}) during which potential and/current is applied, and an OFF-time (T_{OFF}) during which zero current is applied as shown in Fig. 1.

It is possible to control the deposited film composition and thickness in an atomic order by regulating the pulse amplitude and width [4–7]. They favor the initiation of grain nuclei and greatly increase the number of grains per unit area resulting in finer grained deposit with better properties than conventionally plated coatings. Process and circuitry for generating current pulses for electrolytic metal deposition are dealt in literature [8]. In the present paper the authors summarize the recent advancements in PED and PRC plating of metals, alloys, composites and semiconductors.

2. Types of pulse waveform

Modern electronics and microprocessor offers the flexibility of programming, of the applied current waveform. The latter is of two groups: (1) unipolar, where all the pulses are in one direction (with no polarity) and (2) bipolar, where anodic and

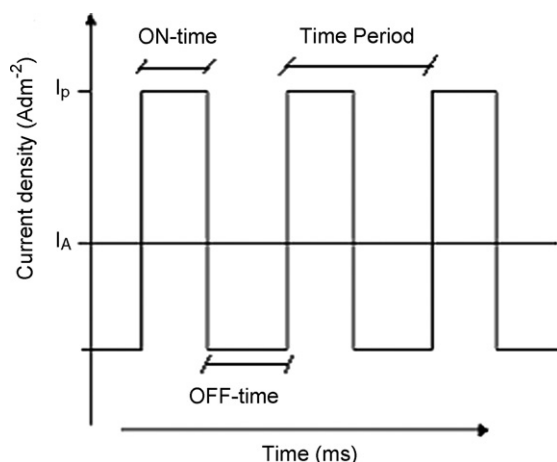

Fig. 1. Typical pulse-current waveform [1–3].

cathodic pulses are mixed. There are many variants on these [9], but the number of variables increases with complexity of the waveform, which makes it more difficult to understand how a particular waveform affects the deposition. Typical waveforms include: (1) cathodic pulse followed by a period without current (or an anodic pulse), (2) direct current (DC) with superimposed modulations, (3) duplex pulse, (4) pulse-on-pulse, (5) cathodic pulses followed by anodic pulses—pulse reverse current (PRC), (6) superimposing periodic reverse on high frequency pulse, (7) modified sine-wave pulses and (8) square-wave pulses. Among these, the square wave pulses have the advantage of an extensive duty cycle range [10].

3. Concepts of pulse and pulse reverse techniques

- In electroplating, a negatively charged layer is formed around the cathode as the process continues. When using DC, this layer charges to a defined thickness and obstructs the ions from reaching the part. In PED, the output is periodically turned off to cause this layer to discharge somewhat. This allows easier passage of the ions through the layer and onto the part.
- High current density areas in the bath become more depleted of ions than low current density areas. During T_{OFF} , ions migrate to the depleted areas in the bath. When pulse T_{ON} occurs, more evenly distributed ions are available for deposition onto the part. The effects of PC & PRC variables on electrodeposition are summarized in literature [11].

Permaloy Corporation [12] has studied pulses superimposition on DC [13]. Duplex pulse systems feature a burst of pulses at one level followed by a burst at another, all in one direction. Pulse-on-pulse systems offer complex wave shapes that have pulses at amplitude riding on top of those of lower amplitude. In PRC technique (Fig. 2) [14], plating current is interrupted and a stripping time is introduced into the plating cycle. PRC have the same effect of replenishing the diffusion layer like PC and selectively dissolves the protrusions of the metal surface to ensure a uniform deposit. The introduction of high frequency PRC reduces the use of additives, which limits the deposit ductility and electrical conductivity [15,16]. PRC avoids the drawbacks of additives while the superimposed pulsation keeps control of the crystal structure [17,18].

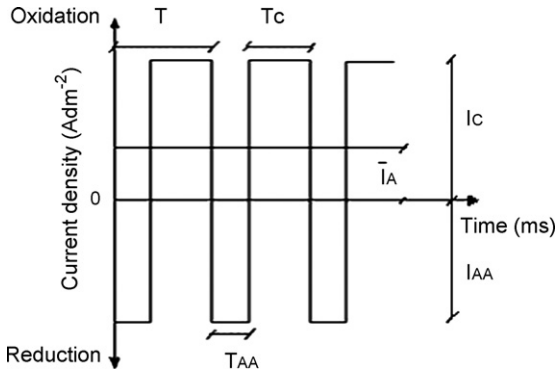

Fig. 2. A typical pulse reverse waveform [14] where, T_{AA} is the anodic time, T_C is the cathodic time, I_{AA} is the anodic current density, I_C is the cathodic current density, \bar{I}_A is the average current density, T is the cycle time.

The introduction of PRC, in PCB manufacturing, eliminates the passive layer formation on the copper anode. The distribution of the electroplated metal is improved when PCB becomes temporarily anodic. The adsorbed additives on the PCB's surface will shield the current and deposit copper during the forward pulse, forming “dog-boned” deposits (Fig. 3). During reverse pulse, the additives were attracted (“electroplated”) to the edges of the drilling hole and results in dog bone additive layer (Fig. 4). The unshielded areas electroplated with organic layer are partially removed (Fig. 5). The last forward pulse finishes without dog-boned deposits (Fig. 6).

Superimposing periodic reverse on high frequency pulse results in a series of pulses with controllable amplitude, frequency and duration that influences deposition characteristics differently compared to PC/PRC technique. This sine-wave pulse system is cheap and consists of output pulse with fast turn- T_{ON} and a slow sinusoidal turn- T_{OFF} . Square-wave pulse

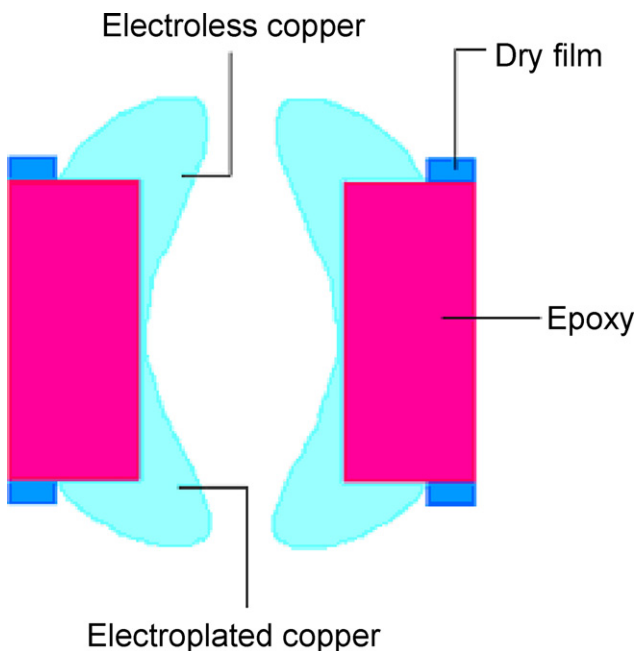

Fig. 3. Copper deposition during forward pulse.

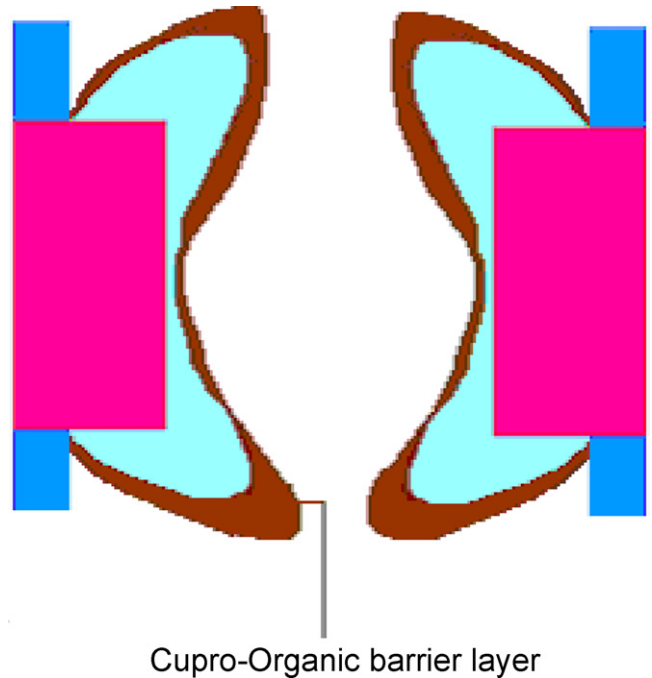

Fig. 4. Barrier-layer deposition during the reverse pulse.

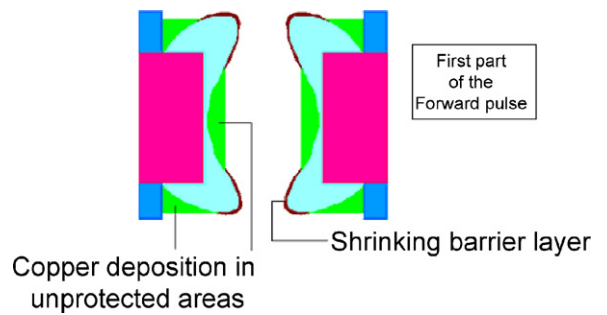

Fig. 5. Shrinking barrier-layer deposition during the forward pulse.

system applied in electronic applications is independent of the power-line frequency facilitating a wide range (>10 kHz).

The double-pulse technique is characterized with two pulse potentials and the corresponding pulse durations [19]. The first pulse, being more negative than critical nucleation potential (E_{CRIT}), is used to initiate the nuclei formation and the sec-

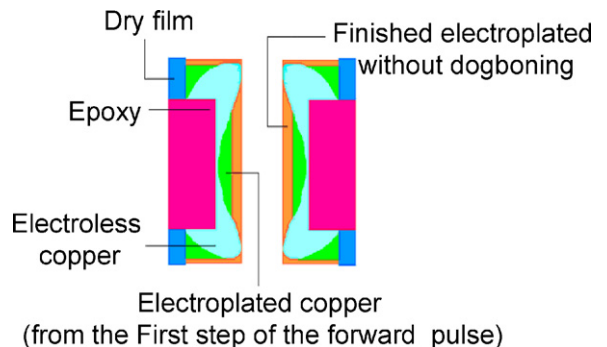

Fig. 6. Copper deposition during the second part of the forward pulse.

ond pulse, more positive than E_{CRIT} but more negative than the reversible potential, is used to control its growth. It is convenient and easy way to produce custom cluster and tailor-made distributions of surface enhanced Raman effect active materials on inert electrode like indium–tin oxide [20,21].

4. Advantage of pulse and pulse reverse techniques

(i) While PED significantly raises the limiting current density (I_L) by replenishing metal ions in the diffusion layer only during T_{OFF} , PRC does it continuously [22]. (ii) In PED, by modifying pulse parameters, deposits with desired composition, structure, porosity and hydrogen content could be obtained [23–29]. (iii) Pulse plating reduces the additive requirement by 50–60%. PRC enhances the bath stability and efficiency with negligible additive consumption [30]. (iv) PRC eliminates thickness build up at high current density areas during current reversal and improves step coverage without pores reaching down to the substrate.

5. Pulse and pulse reverse current parameters

In the conventional DC plating there is only one parameter, namely current density (I), which can be varied. But in PED (Fig. 1), we have three independent variables, viz, (i) ON-time (T_{ON}), (ii) OFF-time (T_{OFF}) and (iii) peak current density (I_P).

In PC, the duty cycle (γ) corresponds to the percentage of total time of a cycle and is given by [31,32]:

$$\text{duty cycle} = \frac{T_{\text{ON}}}{T_{\text{ON}} + T_{\text{OFF}}} = T_{\text{ON}} f \quad (1)$$

where f is frequency, defined as the reciprocal of the cycle time (T).

$$\text{Frequency} = \frac{1}{T_{\text{ON}} + T_{\text{OFF}}} = \frac{1}{T} \quad (2)$$

In practice, pulse plating usually involves a duty cycle of 5% or greater and T_{ON} from μs to ms. PC will deposit metal at the same rate as DC provided the average pulse current density equals the latter. The average current density (I_A), in pulse plating is defined as [33]:

$$I_A = \text{peak current } (I_P) \times \text{duty cycle } (\gamma) \quad (3)$$

In case of PRC technique, the average current (\bar{I}_A) is as given below [34]:

$$\bar{I}_A = \frac{I_C T_C - I_{AA} T_{AA}}{T_{AA} + T_C} \quad (4)$$

In PRC, the duty cycle (γ') is given as below

$$\gamma' = \frac{T_C}{T_{AA} + T_C} \quad \text{with } T_{AA} = T_C \quad (5)$$

where I_C is the cathodic current density, I_{AA} is the anodic current density, T_{AA} is the anodic (reverse) time, and T_C is the cathodic (forward) time. The current efficiency of PRC is always less than that of PC [35].

6. Pulse electrodeposition—deciding factors

6.1. Charging of the electrical double layer (EDL) at the metal–electrolyte interface

The charges are provided to EDL, to raise its potential to the value required for metal deposition at the rate corresponding to I_A . The I_P supplied consists of two parts, (1) a capacitive current, which charges the double layer and (2) a faradic current (I_F), which corresponds to the rate of metal deposition. The charging time (t_C) of EDL is the time required for the I_F to reach 99% of I_P [36] while discharge time (t_D) is the time required to decrease I_F to 1% of I_P . The rapid method for selection of t_C and t_D values in relation to the applied I_P [9] is given below,

$$t_C = \frac{17}{I_P} \quad \text{and} \quad t_D = \frac{120}{I_P}$$

6.2. Mass transport

Mass transport plays an important role in limiting the deposition rate, influences the morphology, deposit properties and the macro- and micro-throwing power. The important factor for mass transport in PC plating is pulse limiting current density (I_L). The value of I_L depends on pulse parameters, particularly T_{ON} . Longer the T_{ON} , smaller would be the value of I_L . The pulse T_{ON} must be short to stay below the I_L , but sufficiently long to fully charge the double layer. The value of the pulse I_L might far exceed DC limiting current density (I_G) [37,38]. Two conditions: (a) $I_A/I_G < 1$ and (b) $I_P/I_L < 1$, are required to obtain compact non-dendritic deposit [39].

In DC plating, powdery deposits are obtained at or near I_G and the allowed applied current density is 10–20% of I_G . In PED, smooth deposits may result even at the I_L , provided pulsating diffusion layer is very small. In PRC, applying short anodic pulses between cathodic pulses allows preferential redissolution of dendrites that might have grown during the cathodic pulses [39–43].

7. Pulse current and deposit properties

Crystallization involves incorporation of adatoms or adions in crystal lattice either by (i) formation of new crystals or (ii) building up of old crystals. The factors affecting case (i) include (a) high adatoms population, (b) high overpotential and (c) low surface diffusion rate and vice versa for case (ii) [9,44]. The factors (a) and (b) can be achieved through high I_P . In PED, high I_P enhances the adatoms population and nucleation rate during T_{ON} . PC can affect the electrocrystallization mechanism and controls the physical and mechanical properties of the electrodeposited metal.

The rate of nuclei formation (ν), is given by [9,45]:

$$\nu = K_1 \exp\left(\frac{-K_2}{|\eta|}\right) \quad (6)$$

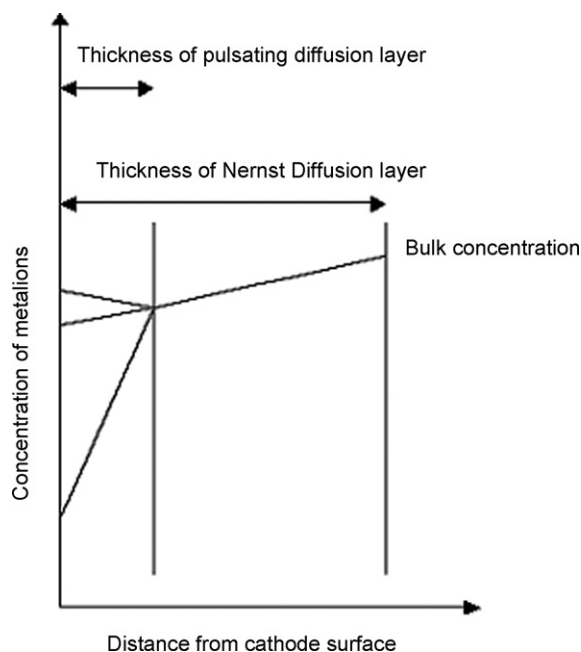

Fig. 7. A simplified illustration of the diffusion system obtained when current pulses are applied to a plating electrolyte [50].

where K_1 is proportionality constant, K_2 including I_P is the amount of energy needed for nucleation and η is the crystallization overpotential. From above equation, it can be inferred that as I_P increases the overpotential increases, which in turn increases the nucleation rate resulting in finer crystals. In PED, fine-grained deposition depends upon what happens during T_{ON} . Current interruption during T_{OFF} encourages re-nucleation due to desorption of impurities.

8. Pulse current and duty cycle/frequency

For the same I_A , the rate of metal deposition in PC could be same as DC plating. At low duty cycle, high I_P is required to obtain the same average deposition rate as DC. With increasing duty cycle PC approaches DC [46–48] and so duty cycle of 33–50% is taken as the minimum value [49].

At high frequency (f), the double layer does not have time to charge fully during the T_{ON} or fully discharge during the T_{OFF} . The PC diffusion layer (Fig. 7), [36,37,50] consists of a stationary layer and a pulsating layer [36]. The total diffusion layer thickness is equivalent to that obtained in DC plating thereby limiting the maximum frequency to ~ 500 Hz. However, at very high I_P , higher frequencies can be employed as charging and discharging of the double layer becomes shorter. The enhanced PC plating rates are mainly due to its effect on electrocrystallization.

9. Pulse current and current distribution

Current distribution depends on potential distribution and the local concentration of electroactive species at the electrode surface [51,52]. At increased current density, the throwing power deteriorates due to dominating primary current distribution [53].

Higher I_P during T_{ON} results in less uniform current distribution irrespective of pulse waveform [36–45,49,51–53]. PC may improve the throwing power by altering the electrolyte's efficiency, hydrogen discharge and deposition mechanism.

10. Pulse current and power consumption

In PED, as discussed under Section 6.2, employing high I_P during T_{ON} reduces the electrode resistance and hence its average cathode potential is lower than in DC. The average cathode potential cannot be used for power calculations because higher peak cathode potential is required during T_{ON} for PC. The greater power consumption in PC can reduce bills for heating electrolytes but may cause overheating, particularly at low duty cycles. [50].

11. Pulse current and additives

The pulse T_{OFF} is important for the enhancement of additive mass transfer [54]. For electrolyte without additive, the derivative of potential with time during T_{ON} is always positive due to the continuous increase of concentration overpotential, while in the presence of an additive, this depends on the latter's specific adsorption kinetics.

In PED of nickel, with increasing amounts of 2-butyne-1,4-diol (BD), the deposit's hardness (220–420 Hv) increases due to reduction in grain size [55]. The concentration of adsorbed BD during T_{ON} is increased due to its replenishment during T_{OFF} . The dendritic morphology of Sn–Ag alloy obtained with increase in I_P between 40 and 60 A dm⁻² [56] is avoided by adding triethanolamine. Addition of sodium dodecyl sulfate during pulse Cu–Co deposition, led to cobalt-rich columnar structure [11,57], suggesting the possibility to produce controlled 3D nanostructures [58].

12. Pulse plating of alloys

PC can influence the structure and composition of an alloy. Uniform composition can be obtained at high frequency pulses (>10 Hz). The alloy deposit may exhibit a composition modulation during T_{ON} and T_{OFF} producing multi-layered coatings (composition modulated alloys) [49,59]. For some applications, a small cathodic or anodic T_{OFF} current may be applied (Fig. 8),

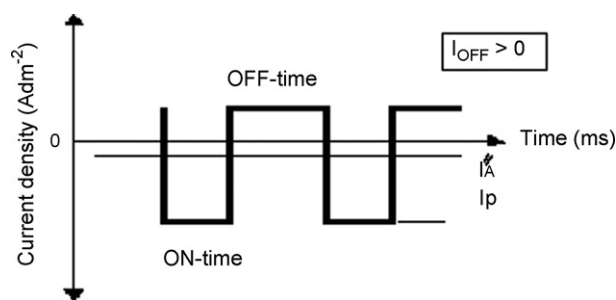

Fig. 8. Schematic of current density pulses: application of anodic off-time current density, $I_{OFF} > 0$. The thin line represents the average current density I_A . Also shown are the T_{ON} , T_{OFF} and I_P [49].

and the corresponding average current density (I''_A) is given as

$$I''_A = (I_P \times \gamma) + I_{OFF}(1 - \gamma) \quad (7)$$

where I_{OFF} is the current density at T_{OFF} (taking anodic current as positive and cathodic current as negative). Ternary alloys can be produced readily using PC than DC [49].

The advantages of PRC technique in alloy plating include: (a) adjustment of reverse pulse current density to obtain alloys of a specific composition/grain size at a constant temperature, (b) in situ modification of applied current waveform enabling the production of patterned nanostructures and (c) produce quality deposits over entire composition range.

13. PC and PRC deposition of individual metals and alloys

13.1. Chromium and its alloys

The current efficiency of chromium deposition from the conventional sulfate baths were increased to 38% under low and high frequency PC plating when the anodic to cathodic charge ratio lies between 0.002 and 0.0085 [60]. The unipolar pulses and PRC technique reduces the stress enabling the production of crack-free deposits [50,61–63]. PC plated chromium deposits were observed to have refined grains with enhanced hardness (~ 1000 Hv), surface crack density and corrosion resistance than that plated with DC at same current density [64,65].

The HCP structured chromium deposits obtained at 60 A dm^{-2} and pulsating frequencies between 0.05 and 1 kHz [66] were changed to BCC at higher frequencies (5–50 kHz) possessing superior mechanical property [63]. The size of the nodules and the wear resistance depends on the chrome growth kinetics and T_{ON}/T_{OFF} [67,68]. Multilayer Cr–Ni, with alternate amorphous chromium-rich layer and equiaxed grains of ~ 7 nm in nickel-rich layer were produced using PC [69].

13.2. Cobalt alloys

Ni–Co alloy deposits having a compact oxide film with twice the cobalt content could be obtained at low I_P and high pulse T_{OFF} [70]. The composition of Co–Fe alloys shows some variation at low current density with PRC due to preferential dissolution of iron during the anodic pulse whereas it is independent of I_A with DC and PC.

PRC technique can produce pure Ni–Co and Co–Ni–Fe deposits with relatively low residual stress [71] without additives. This technique enhances the deposit's hardness (~ 220 Hv) by reducing the cobalt content [29]. Molybdenum-rich (35–40 wt.%) Co–Mo alloys with improved mechanical properties can be obtained using PC [72].

13.3. Copper and its alloys

Nanocrystalline, ultra-fine grained (8–100 nm) [73] and polycrystalline copper foils ($\sim 25 \mu\text{m}$ thick) were produced at 10 kHz [74,75]. Presence of numerous big grains (~ 550 nm) on the cop-

per surface and many small clusters of ~ 50 nm diameter were reported [76]. Addition of polyethylene glycol and EDTA during pulse copper deposition increases thickness, current efficiency and throwing power [77]. PRC enables release of trapped hydrogen in deposits leading to softer coating than those obtained with PC and DC [18].

In PED of Cu–Sn alloy deposition, the metal ratios can be easily varied by varying pulse parameters [31]. A mixture of Cu_6Sn_5 and pure Sn can be obtained for a tin-rich alloy [78] and $\text{Cu}_{41}\text{Sn}_{11}$ is favored instead of Cu_3Sn [79] for a copper-rich alloy. A mixed granular copper alloy phase and cobalt can be obtained at 1 kHz whereas a coherent super lattice structure with 50% copper at 0.2 kHz and 80% cobalt at 0.4 kHz can be obtained using PC [80].

In PED of Mn–Cu, decreasing T_{OFF} results in uniform and homogeneous films with improved mechanical properties [81,82]. In PED of Cu–Ni [83], the films produced are predominantly copper at low I_P , copper and nickel at moderate I_P and nickel at high I_P [84,85] due to the deposition of copper at the limiting current while nickel is deposited during T_{ON} [86,87].

13.4. Gold and its alloys

PED of gold on aluminum produce deposits with smaller grain size with less porosity [88], high surface density and better corrosion resistance than the DC plated gold [89]. At 5 A dm^{-2} , nanocrystalline gold (23 nm) were obtained [90] due to desorption of gold adatoms and adsorption of inhibitor as sulfur–gold complexes. As mentioned in Section 6.2, for phosphate, citrate and cyanide gold electrolytes the I_L were higher than I_G [38]. Between 0.5 and 1 kHz [91] deposits with improved strength [92], purity and hardness [93] were produced. PC enhances the deposition rate at higher I_P and temperature [94] and reduces the required thickness leading to gold savings [89].

PED could produce polymer-free semi-bright Au–Co [95] and Au–Ni [93] alloy deposits. The straight walled gold bumps were produced at 5 A dm^{-2} , as the photo-resist would deform at high I_P . The cathode diffusion layer sufficiently recovers at long T_{OFF} , producing smooth gold films [96].

13.5. Nickel and its alloys

Nickel deposits with improved morphology and mechanical properties [97–104] could be produced by altering pulse parameters. As seen under Section 8, pulse frequency between 100 and 200 Hz [59] permits higher I_P (300 A dm^{-2} [105]) leading to fine-grained deposits [104,106,107].

At the same I_P , T_{ON} and electrodeposition time, either ramp or triangular pulsed waveform produced best surface finish in electroforming of nickel [108]. PRC technique produced ultra-thin and void-free nickel films at 1.2 A dm^{-2} , 90% duty cycle and 400 kHz [109]. Their excellent precision, durability and surface smoothness make them suitable for high-resolution applications.

PED of Ni–Mo alloy at 0.04 A dm^{-2} and 0.1 kHz resulted in nanocrystalline (7–10 nm) crack-free deposits [110]. Between 0.05–0.1 kHz, $20\text{--}40 \text{ A dm}^{-2}$ and 10% duty cycle, nanocrys-

talline Ni–Cu deposits (26–36 wt.%Cu) with superior corrosion resistance better than Monel-400 could be obtained [111]. In PRC deposition of Fe–Ni alloy [34], the variation of iron content with I_P is less compared to PED and DC plating [12,112,113]. Pulse timings in Ni–W alloy, must be such that they operate on each monolayer, producing a homogeneous alloy with reduced tungsten level [114,115].

13.6. Platinum

The most warranted research on platinum and its alloy deposition is for fuel cell applications. Of various techniques available, electrodeposition particularly using PC is considered to be the most viable one to minimize the platinum content without sacrificing the catalytic activity.

Vilambi et al [116] and Taylor et al. [117] used PED to deposit 2–3.5 nm platinum on Nafion membrane in regions of ionic and electronic conductivity. The catalyst produced 320 mA cm⁻² at 0.7 V with 0.05 mg_{Pt} cm⁻² loading [118]. PED was performed directly (H₂PtCl₆ impregnated carbon) on a glassy carbon [119] and within active layer of Nafion depositing 20% Pt (of 2–4 nm) [120]. However, the chloride ions, in the precursor reduced the metal's catalytic activity [121]. PEM fuel cell cathode prepared by PED [122] containing only 62% of platinum used in the conventional E-TEK electrode [123] generated 0.33 A cm⁻² as against 0.2 A cm⁻² by the latter at the same voltage (0.8 V).

During PED, the amount of platinum loading can be varied with the total charge used and the concentration of platinum precursor. Lee et al. [124] obtained 0.25 mg_{Pt} cm⁻² with 3–5 nm size platinum particles [125] at 300 mA cm⁻² and 10/100 ms of T_{ON}/T_{OFF} . PED from aqueous platinum salt led to a particle size of 70 nm [126,127] whereas in presence of glycerol the size got reduced to <10 nm [128].

13.7. Silver and its alloys

PC plated Ag–Sn alloys had enhanced tarnish resistance [9]. Pure silver deposits and 97% pure cobalt deposits in the pores of track-etched membranes were obtained for giant magneto resistance applications [129]. In Pd–Ag deposition, an increase of either T_{ON} , I_P or duty cycle led to a decrease in current efficiency of silver with its concentration in the deposit [130]. Unsymmetrical square wave current was employed to prepare poly aniline–silver (PANI–Ag) nanocomposite film having a fibrous structure with silver nanoparticles dispersed in the PANI matrix [131]. The nodular structure of silver disappears with increased I_{AA} and at low T_{OFF} with PRC technique [132].

13.8. Zinc and its alloys

PC produced nanocrystalline zinc deposits at 200 A dm⁻² [133–135]. With additives [135,136], deposits with 56 nm grain size with remarkable hardness [4] and corrosion rate 60% lower than electrogalvanized steel could be produced [137]. Ye et al. [138] related the ductility of zinc coatings to the percentage of crystallites that lie at inclined angles with respect to the basal planes. Pulse technique resulted [139] in leveling off the

DC growth-dependent habits and a [00.2] texture at 20 A dm⁻² resulted in compact zinc deposit.

In PED of Zn–Co alloy, the cobalt content increased with T_{ON} and I_P [140]. In PRC technique, the cobalt content is higher for a given I_P [14] due to the selective dissolution of zinc in the alloy during the cathodic cycle [17]. The deposits obtained were smooth with reduced internal stress due to the removal of hydrogen during reverse current [141]. Due to the existence of γ -phase and a homogeneous compact structure, pulsed Zn–Ni deposit exhibited better corrosion properties [142–146]. Pulse deposited Zn (25–40%)–Mn alloys had a single ϵ -phase [147] at 0.02 A dm⁻², 0.01–0.05 kHz and 25–50% duty cycle. While PC and PRC led to very low current efficiency despite uniform deposition, superimposed pulse produced the above alloy with maximum corrosion resistance and highest current efficiency [148].

13.9. Composites

PED improved the hardness (\sim 500 kgfcm⁻²) of Ni/SiC composite coatings at longer T_{OFF} [149] that favored grain refinement of nickel and SiC incorporation [150]. PRC technique improved SiC content in the composite by six times [151]. The tribological behavior of the Ni–P–SiC composite was better than that of DC plated deposits [152]. Microhardness of PC plated Ni–diamond composite (611 Hv) is higher than that of DC plated composite (540 Hv) [153]. The grain size and hardness of PRC plated Ni–Co/nanoalumina composite [154] were better than those of DC plated composites due to enhanced nucleation rate. Due to partial dissolution of nickel in the anodic cycle, Ni–C nanofiber composite obtained by PRC technique had 5–6 wt.% higher fiber content [155,156].

13.10. Semiconductors

The grain size of CdSe films decreased at 6.25% duty cycle [157]. PED of ZnSe produced zinc and selenium elemental phases at low frequency (0.0001 kHz) and much improved coatings in the range of 0.001–0.01 kHz while at frequencies exceeding 0.01 kHz, the film quality declined, since too short pulses induced a strong capacitive effect [158]. In PED of CdTe, increase in I_P produced a mixture of cubic and hexagonal structures. The deposit's pre-band gap transmission value decreased due to oxide formation. Hexagonal CdTe deposits obtained at long T_{OFF} and short T_{ON} showed better optical properties [159]. Richoux et al. [160] reported that T_{ON} affects the morphology and the composition of the Bi₂Te₃ deposits. In PED of GaAs [161], increase in duty cycle (10–50%), decreased the band gap due to decrease in grain size suggesting that the film can be used as a solar cell [162]. The best quality of pulsed TiB₂ deposit [163,164] is produced at 3:1 (T_{ON}/T_{OFF} ratio) and at 0.005–0.1 kHz [165].

14. Technological applications

Pulse plating is used to a large degree for plating on electronic connectors and switch contacts. Less stressed pulse plated deposits made it easy to stamp and form contacts after plating.

The economic gains surpass the relatively high cost of pulse power supplies.

Manufacturers of semiconductor lead (Pb) frames are using PC to increase the reliability of wire bonds and to enhance deposition rate. High-speed gold and silver-plating solutions specially formulated for pulse deposition are available commercially.

In Printed Circuit Boards (PCB) industry, there is a need for miniaturization of high-density interconnections. The use of PRC for the deposition of copper from acidic electrolytes containing additives, produce enhanced throwing power especially in the holes [165–167]. Circuit traces can be positioned closer together without shorting one another with the use of pulse technology, for high-density circuitry applications in microelectronics industry [168,169].

15. Disadvantages of pulse and pulse reverse techniques

The disadvantages of pulse current and pulse reverse technique, although minimal are:

1. In most cases, the cost of a pulse rectifier is much greater than a DC unit. It is a highly regulated and sophisticated design that costs more to manufacture.
2. The technology requires one to think and plan ahead with a series of procedures to follow in order to obtain the best results.
3. For the chemical manufacturers, the requirement for additives is reduced.

16. Conclusion

This review indicates the advantages and disadvantages of employing PC and PRC technique in plating. Pulse current produces invariably fine-grained structures so that physical, chemical and mechanical properties are changed advantageously for many metals and alloys. Pulse and the related techniques enable the production of newer types of deposits, which were considered impossible so far. Pulse technique might become a commonly used tool for other electrochemical processes also in future (e.g., electro-discharge machining, electro-etching and electro-cleaning).

Acknowledgement

The authors wish to express their sincere thanks to the Director, CECRI for the encouragement given and permission to publish this paper.

References

- [1] M. Ghaemi, L. Binder, *J. Power Sources* 111 (2) (2002) 248.
- [2] A. Marlot, P. Kern, D. Landolt, *Electrochim. Acta* 48 (1) (2002) 29.
- [3] K.M. Yin, S.L. Jan, C.C. Lee, *Surf. Coat. Technol.* 88 (1997) 219.
- [4] S. Kainuma, S. Ishikura, K. Hisatake, *J. Magn. Soc. Jpn.* 21 (1995) 889.
- [5] T. Houga, A. Yamada, Y. Ueda, *J. Jpn. Inst. Met.* 64 (2000) 739.
- [6] Y. Ueda, N. Hataya, H. Zaman, *J. Magn. Mater.* 156 (1996) 350.
- [7] M. Alper, K. Attenborough, R. Hart, S.J. Lance, D.S. Lashmore, C. Younes, W. Schwarzacher, *Appl. Phys. Lett.* 63 (1993) 2144.
- [8] N.V. Mandich, HBM Engineering Co., Lansing, ILL, *Met. Finish.* (2002).
- [9] J. Puipe, F. Leaman, *Theory and Practice of Pulse Plating*, AESF Publication, Orlando, 1986.
- [10] J.C. Puipe, N. Ibl, H. Angerer, H.J. Schenk, *Oberfläche Surf.* 20 (1979) 77.
- [11] J.J. Kelly, P.E. Braddey, D. Landolt, *J. Electrochem.* 147 (2000) 2975.
- [12] Permaloy Corporation, Ogden, Utah, US Patent, 3,857,766 (1972).
- [13] V. Raj, M.P. Rajaram, G. Balasubramaniam, S. Vincent, D. Kanagaraj, *Trans. Inst. Met. Finish.* 81 (2003) 114.
- [14] J.-Y. Fei, G.D. Wilcox, *Electrochim. Acta* 50 (2005) 2693.
- [15] E. Gutierrez, *CircuitTree* (2001) 46.
- [16] G. Milad, *PC FAB.* 20 (1997) 36.
- [17] K.M. Yin, *J. Electrochem. Soc.* 150 (6) (2003) C435.
- [18] P. Leisner, P. Moller, M. Fredenberg, I. Belov, *Trans. Inst. Met. Finish.* 85 (1) (2007) 40.
- [19] A. Scheludko, M. Todorova, *Bull. Acad. Bulg. Sci. Phys.* 3 (1952) 61.
- [20] G. Sandmann, H. Dietz, W. Plieth, *J. Electroanal. Chem.* 491 (1–2) (2000) 78.
- [21] M. Ueda, H. Dietz, A. Anders, H. Kneppa, A. Meixner, W. Plieth, *Electrochim. Acta* 48 (4) (2002) 377.
- [22] S. Roy, A. Connell, M. Ludwig, N. Wang, T.O. Donnell, M. Brunet, P.M. Closkey, C.O. Mathuna, A. Barman, R.J. Hicken, *J. Magn. Mater.* 290–291 (2005) 1524.
- [23] S. Yoshimura, S. Chida, E. Sato, N. Kubota, *Met. Finish.* 84 (1986) 39.
- [24] Y. Fukumoto, Y. Kawashima, K. Handa, Y. Hayashi, *Met. Finish.* 82 (1984) 77.
- [25] C. Kollia, Z. Loizos, N. Spyrellis, *Surf. Coat. Technol.* 45 (1991) 155.
- [26] N. Ibl, *Metalloberfläche* 33 (1979) 51.
- [27] J.Cl. Puipe, N. Ibl, *Plat. Surf. Finish.* 67 (1980) 68.
- [28] P.C. Andricacos, H.Y. Cheh, H.B. Linfold, *Plat. Surf. Finish.* 64 (1977) 44.
- [29] A.M. Alfantazi, G. Brehaut, U. Erb, *Surf. Coat. Technol.* 89 (1997) 239.
- [30] P.T. Tang, *Trans. Inst. Met. Finish.* 85 (2007) 51.
- [31] S.D. Beattie, J.R. Dahn, *J. Electrochem. Soc.* 150 (2003) A894.
- [32] N. Masuko, T.O.a.Y.I. *Electrochem. Technol. Innov. New Dev.* (1996).
- [33] J.Cl. Puipe, N. Ibl, *J. Appl. Electrochem.* 10 (1980) 775.
- [34] D.L. Grimmitt, M. Schwartz, K. Nobe, *The Electrochem. Soc. Inc.* 140 (1993) 973.
- [35] K.M. Yin, S.L. Jan, *Trans. Inst. Met. Finish.* 74 (1996) 51.
- [36] N. Ibl, *Surf. Technol.* 10 (1980) 81.
- [37] M. Datta, D. Landolt, *Surf. Technol.* 25 (1985) 110.
- [38] H.Y. Cheh, *J. Electrochem. Soc.* 118 (1971) 551.
- [39] S. Roy, D. Landolt, *J. Appl. Electrochem.* 27 (1997) 299.
- [40] B. Nguyen, E. Chainet, *Acta. Chim.* 4 (1990) 167.
- [41] V.P. Khlyntsev, V.M. Kozlov, T.I. Pozdeeva, *Sov. Electrochem.* 25 (1989) 40.
- [42] F. Creusat, J. Pagetti, *Galvano-Organo Trait. Surf.* 590 (1988) 875.
- [43] W. Kim, R. Weil, *Surf. Coat. Technol.* 31 (1987) 143.
- [44] R.T.C. Choo, J.M. Toguri, A.M. El-Sherik, U. Erb, *J. Appl. Electrochem.* 25 (1995) 384.
- [45] M. Paunovic, M. Schlesinger, *Fundam. Electrochem. Depos., Electrochem. Soc.* (1998).
- [46] E. Toth-Kader, L. Peter, T. Becsei, J. Toth, L. Pogany, T. Tarnoczi, P. Kamasa, I. Bakonyi, J. Lang, A. Cziraki, W. Schwarzacher, *J. Electrochem. Soc.* 147 (2000) 3311.
- [47] W.R.A. Meuleman, S. Roy, L. Peter, I. Bakonyi, *J. Electrochem. Soc.* 151 (2004) C256.
- [48] G. Nabiyouni, O.I. Kasyutich, S. Roy, W. Schwarzacher, *J. Electrochem. Soc.* 149 (2002) C218.
- [49] D. Landolt, *Fundamental Aspects of Alloy Plating*, AESF SUR/FIN, 2001.
- [50] T. Pearson, J.K. Dennis, *Trans. Inst. Met. Finish.* 69 (1991) 75.
- [51] O. Dossenbach, in: J.Cl. Puipe, F. Leaman (Eds.), *Pulse Plating*, 6th ed., AESF, Orlando, 1980.
- [52] S.I. Kwak, K.M. Jeong, S.K. Kim, H.J. Sohn, *J. Electrochem. Soc.* 143 (1996) 2770.

- [53] N. Ibl, Proceedings of A.E.S.F. International Pulse Plating Symposium Rosemont, 6–7, Illinois, 1981.
- [54] K.M. Yin, *J. Electrochem. Soc.* 145 (1998) 3851.
- [55] E.A. Pavlatou, M. Raptakis, N. Spyrellis, *Surf. Coat. Technol.* 201 (2007) 4571.
- [56] B. Neveu, F. Lallemand, G. Poupon, Z. Mekhalif, *Appl. Surf. Sci.* 252 (2006) 3561.
- [57] D. Landolt, A. Marlot, *Surf. Coat. Technol.* 169–170 (2003) 8.
- [58] J.J. Kelly, M. Cantoni, D. Landolt, *J. Electrochem.* 130 (1983) 1987.
- [59] A.M. El-Sherik, U. Erb, J. Page, *Surf. Coat. Technol.* 88 (1996) 70.
- [60] P. Leisner, G. Bech-Nielsen, P. Moller, *J. Appl. Electrochem.* 23 (1993) 1232.
- [61] V.M. Jose, N.W. Parthasaradhy, *Galvanotechnik* 63 (1972) 523.
- [62] V.L. Nesnidal, Proceedings. AESF International Pulse Plating Symposium, Boston, 1979.
- [63] T. Pearson, J.K. Dennis, *Plat. Surf. Finish.* 26 (1989) 64.
- [64] S. Mohan, R.M. Krishnan, K.G. Ranganathan, S. Raman, B. Ganeshkari, H. Latha, *Trans. Inst. Met. Finish.* 81 (2003) 172.
- [65] C.A. Huang, W. Lin, M.J. Liao, *Corros. Sci.* 48 (2006) 460.
- [66] J.H. Chai, D.Y. Chang, S.C. Kwon, *Plat. Surf. Finish.* (1989) 80.
- [67] C. Yong, N.I. Baik, S.I. Hong, *Thin Solid Films* 397 (2001) 24.
- [68] C. Yong, M. Kim, S.C. Kwon, *Surf. Coat. Technol.* 169–170 (2003) 81.
- [69] C.A. Huang, C.Y. Chen, C.C. Hsu, C.S. Lin, *Scripta Mater.* 57 (2007) 61.
- [70] B. Tury, M.L. Varsanyi, S. Roy, *Appl. Surf. Sci.* 253 (2007) 3103.
- [71] P.T. Tang, T. Watanabe, J.E.T. Anderson, G. Bech-Nielsen, *J. Appl. Electrochem.* 25 (1995) 347.
- [72] E. Pellicer, E. Gomez, E. Valles, *Surf. Coat. Technol.* 201 (2006) 3103.
- [73] H. Natter, R. Hempelmann, *J. Phys. Chem.* 100 (1996) 19525.
- [74] M.F. El-Shazly, J.L. White, E.W. Brooman, AESF Third International Pulse Plating Symposium, 1986.
- [75] P. Woo, U. Erb, Proceedings of the IPC Printed Circuits Expo, APEX and Designers Summit, 2006, S37-02-1.
- [76] C.-C. Hu, C.-M. Wu, *Surf. Coat. Technol.* 176 (2003) 75.
- [77] S. Mohan, V. Raj, *Trans. Inst. Met. Finish.* 83 (2005) 194.
- [78] M. Hansen, *Constitution of Binary Alloys*, 2nd ed., Genium Publishers Corp., Schneectady, New York, 1989.
- [79] S.D. Beattie, J.R. Dahn, *J. Electrochem. Soc.* 150 (2003) C457.
- [80] D. Gupta, A.C. Nayak, M. Sharma, R.R. Singh, S.K. Kulkarni, R.K. Pandey, *Thin Solid Films* 513 (2006) 187.
- [81] F. Mangolini, L. Magagnin, P.L. Cavallotti, *Trans. Inst. Met. Finish.* 85 (2007) 27.
- [82] F. Mangolini, L. Magagnin, P.L. Cavallotti, *J. Electrochem. Soc.* 153 (2006) C623.
- [83] I. Baskaran, T.S.N. Sankara Narayanan, A. Stephen, *Mater. Lett.* 60 (2006) 1990.
- [84] L.H. Bennett, L.J. Swartzendruber, D.S. Lashmore, R. Oberle, *Phys. Rev. B: Condens. Matter.* 40 (1989) 4633.
- [85] L.H. Bennett, L.J. Swartzendruber, H. Etteudui, U. Atzmony, *J. Appl. Phys.* 67 (1990) 4904.
- [86] S. Roy, D. Landolt, *J. Electrochem. Soc.* 142 (1995) 3021.
- [87] S. Roy, M. Matlosz, D. Landolt, *J. Electrochem. Soc.* 141 (1994) 1500.
- [88] Y. Lee, S.K. Ahn, Y. Roh, *Surf. Coat. Technol.* 193 (2005) 137.
- [89] S. Mohan, V. Raj, *Trans. Inst. Met. Finish.* 83 (2005) 72.
- [90] O. Yevtushenko, H. Natter, R. Hempelmann, *Thin Solid Films* 515 (2006) 353.
- [91] C.H. Seah, S. Mridha, L.H. Chan, *J. Mater. Process Technol.* 114 (2001) 233.
- [92] T.E. Dinan, H.Y. Cheh, *J. Electrochem. Soc.* 139 (1992) 2.
- [93] A. Knodler, *Metalloberfläche* 28 (1974) 465.
- [94] J.-F. Fallot, M. Berger, AESF Third International Pulse Plating Symposium, 1986.
- [95] F.H. Reid, *Metalloberfläche* 30 (1976) 453.
- [96] H. Honma, *Electrochim. Acta* 47 (2001) 75.
- [97] M. Saitou, W. Oshikawa, M. Mori, A. Makabe, *J. Electrochem. Soc.* 148 (2001) C780.
- [98] E.A. Pavlatou, M. Raptakis, N. Spyrellis, *Surf. Coat. Technol.* 201 (2007) 4571.
- [99] W.N. Lei, D. Zhu, N.S. Qu, *Trans. Inst. Met. Finish.* 82 (2004) 141.
- [100] N.S. Qu, D. Zhu, K.C. Chan, W.N. Lei, *Surf. Coat. Technol.* 168 (2003) 123.
- [101] H. Wakabayashi, N. Sato, M. Sone, Y. Takada, H. Yan, K. Abe, K. Mizumoto, S. Ichihara, S. Miyata, *Surf. Coat. Technol.* 190 (2005) 200.
- [102] C. Yang, Z. Yang, M. An, J. Zhang, Z. Tu, C. Li, *Plat. Surf. Finish.* 88 (2001) 116.
- [103] R. Mishra, R. Balasubramaniam, *Corros. Sci.* 46 (2004) 3019.
- [104] R. Mishra, B. Basu, R. Balasubramaniam, *Mater. Sci. Eng.* 373 (2004) 370.
- [105] W.N. Lei, D. Zhu, N.S. Qu, *Trans. Inst. Met. Finish.* 80 (2002) 205.
- [106] C. Kollia, N. Spyrellis, J. Amblard, M. Froment, M. Froment, G. Maurin, *J. Appl. Electrochem.* 20 (1990) 1025.
- [107] C.K. Chung, W.T. Chang, *Microsystem Technologies*, Springer-Verlag 2006, 10.1007/s00542-006-0194-z.
- [108] K.P. Wong, K.C. Chan, T.M. Yue, *Surf. Coat. Technol.* 115 (1999) 132.
- [109] Y. Awad, E. Lavallee, J. Beauvais, D. Drouin, L.K. Mun, P. Yang, M. Cloutier, D. Turcotte, *Thin Solid Films* 515 (2007) 3040.
- [110] Suryanto, T.S. Eagleton, L.G. Earwaker, J.P.G. Farr, I.P. Jones, *Trans. Inst. Met. Finish.* 85 (2007) 34.
- [111] S.K. Ghosh, A.K. Grover, G.K. Dey, M.K. Totlani, *Surf. Coat. Technol.* 126 (2000) 48.
- [112] P. Tsay, C.C. Hu, *J. Electrochem. Soc.* 149 (2002) 492.
- [113] P. Tsay, C.-C. Hu, C.-K. Wang, *Mater. Chem. Phys.* 89 (2005) 275.
- [114] A.J. Detor, C.A. Schuh, *Acta Mater.* 55 (2007) 371.
- [115] A.J. Detor, C.A. Schuh, US Patent Application 11/147, 146 (2006).
- [116] N.R.K. Vilambi, E.B. Anderson, E.J. Taylor, U.S. Patent 5,084,144 (1992).
- [117] E.J. Taylor, E.B. Anderson, N.R.K. Vilambi, *J. Electrochem. Soc.* 139 (1992) L45.
- [118] K.H. Choi, H.S. Kim, T.H. Lee, *J. Power Sources* 75 (1998) 230.
- [119] O. Antoine, R. Durand, F. Gloaguen, F. Novel-Cattin, *Eur. Pat. Appl.* 788 (1997), 174A.
- [120] O. Antoine, R. Durand, *Electrochem. Solid state Lett.* 4 (2001) A55.
- [121] T.J. Schmidt, U.A. Paulus, H.A. Gasteiger, R.J. Behm, *J. Electroanal. Chem.* 508 (2001) 41.
- [122] H. Kim, B.N. Popov, *Electrochem. Solid State Lett.* 7 (2004) A71.
- [123] G.P. Henry, A.A. Robert, U.S. Patent 4,044,193 (1973).
- [124] J. Lee, J. Seo, K. Han, H. Kim, *J. Power Sources* 163 (2006) 349.
- [125] S. Adora, Y. Soldo-Olivier, R. Faure, R. Durand, *J. Phys. Chem. B* 105 (2001) 10486.
- [126] B. Rajesh, K.R. Thampi, J.-M. Bonard, B. Viswanathan, *Bull. Mater. Sci.* 23 (5) (2000) 341.
- [127] V. Lordi, N. Yao, J. Wei, *Chem. Mater.* 13 (2001) 733.
- [128] X. Chen, N. Li, K. Eckhard, L. Stoica, W. Xia, J. Assmann, M. Muhler, W. Schuhmann, *Electrochem. Commun.* 9 (2007) 1348.
- [129] S. Valizadeh, G. Holmbom, P. Leisner, *Surf. Coat. Technol.* 105 (1998) 213.
- [130] O. Dossenbach, B. Sturzenegger, J.C. Puipe, AESF Third International Pulse Plating Symposium, 1986.
- [131] H.H. Zhou, X.H. Ning, S.L. Li, J.H. Chen, Y.F. Kuang, *Thin Solid Films* 510 (2006) 164.
- [132] C. Swarez, E. Chavez, J.A. Diez, H. Grande, R. Guixa, *Trans. Inst. Met. Finish.* 85 (2007) 46.
- [133] Kh. Saber, C.C. Koch, P.S. Fedkiw, *Mater. Sci. Eng. A* 341 (2003) 174.
- [134] M.C. Li, L. Jiang, W.Q. Zhang, Y.H. Qian, S.Z. Luo, J.N. Shen, *J. Solid State Electrochem.* 11 (2007) 549.
- [135] Youssef, C.C. Koch, P.S. Fedkiw, *J. Electrochem. Soc.* 151 (2004) 103.
- [136] M.C. Li, L. Jiang, W.Q. Zhang, Y.H. Qian, S.Z. Luo, J.N. Shen, *J. Solid State Electrochem.* 11 (2007) 1319.
- [137] Kh.M.S. Youssef, C.C. Koch, P.S. Fedkiw, *Corros. Sci.* 46 (2004) 51.
- [138] X. Ye, J.P. Celis, M.De. Bonte, J.R. Roos, *J. Electrochem. Soc.* 141 (1994) 2698.
- [139] D. Vasilakopoulos, M. Bouroushian, N. Spyrellis, *J. Mater. Sci.* 41 (2006) 2869.
- [140] A. Stankevi, K. Leinartas, G. Bikulci Ius, D. Virbalyt, A.S. Ius, E. Juzeli, *J. Appl. Electrochem.* 28 (1998) 89.
- [141] E.M.K. Hillier, M.J. Robinson, *Corros. Sci.* 46 (2004) 715.

- [142] H. Ashassi-Sorkhabi, A. Hagrah, N. Parvini-Ahmadi, J. Manzoori, *Surf. Coat. Technol.* 140 (2001) 278.
- [143] Y.F. Jiang, L.F. Liu, C.Q. Zhai, Y.P. Zhu, W.J. Ding, *Electrochim. Acta* 50 (2005) 5573.
- [144] A.M. Alfantazi, U. Erb, *Corrosion* 52 (1996) 880.
- [145] S.O. Pagotto Jr., C. Marina de Alvarenga Freire, M. Ballester, *Surf. Coat. Technol.* 122 (1999) 10.
- [146] J. Bajat, M.D. Maksimovi, Goran R. Radovi, *Appl. Surf. Sci.* 252 (2006) 3561.
- [147] C. Muller, M. Saret, T. Andreu, *J. Electrochem. Soc.* 150 (2003) C772.
- [148] C. Muller, M. Sarret, T. Andreu, *Electrochim. Acta* 48 (2003) 2397.
- [149] F. Hu, K.C. Chan, *Appl. Surf. Sci.* 233 (2004) 163.
- [150] P. Gyftou, M. Stroumbouli, E.A. Pavlatou, N. Spyrellis, *Trans. Inst. Met. Finish.* 80 (2002) 88.
- [151] E.J. Podlaha, D. Landolt, *J. Electrochem. Soc.* 144 (1997) L200.
- [152] K.-H. Hou, W.-H. Hwu, S.-T. Ke, M.-D. Ger, *Mater. Chem. Phys.* 100 (2006) 54.
- [153] W.-H. Lee, S.-C. Tang, K.-C. Chung, *Surf. Coat. Technol.* 120–121 (1999) 607.
- [154] L.M. Chang, M.Z. An, H.F. Guo, S.Y. Shi, *Appl. Surf. Sci.* 253 (2006) 2132.
- [155] F. Wang, S. Arai, M. Endo, *Electrochem. Commun.* 7 (2005) 674.
- [156] S. Arai, M. Endo, N. Kaneko, *Carbon* 42 (2004) 641.
- [157] V. Swaminathan, K.R. Murali, *J. Cryst. Growth* 279 (2005) 229.
- [158] M. Bouroushian, T. Kosanovic, N. Spyrellis, *J. Appl. Electrochem.* 36 (2006) 821.
- [159] R.K. Sharma, G. Singh, A.C. Rastogi, *Sol. Energy Mater. Sol. Cells* 82 (2004) 201.
- [160] V. Richoux, S. Diliberto, C. Boulanger, J.M. Lecuire, *Electrochim. Acta* 52 (2007) 3053.
- [161] K.R. Murali, V. Subramaniam, N. Rangarajan, A.S. Lakshmanan, S.K. Rangarajan, *J. Mater. Sci. Mater. Electron.* 2 (1991) 149.
- [162] K.R. Murali, D.C. Trivedi, *J. Phys. Chem. Solids* 67 (7) (2006) 1432.
- [163] J. Faucheu, W. Wery, P. Bercot, J. Pagetti, M. Tauchoz, In: *International Union of surface finishing, Interfinish*, 1992.
- [164] G. Ett, J. Pessine, *Electrochim. Acta* 44 (1999) 2859.
- [165] J. Barthelmes, *Trans. Inst. Met. Finish.* 78 (2000) 135.
- [166] E.J. Taylor, J.J. Sun, M.E. Inmar, *Plat. Surf. Finish.* (2000) 68.
- [167] S.C. Kou, A. Hung, *Plat. Surf. Finish.* (2000) 140.
- [168] L. Missel, P. Duke, T. Montalbano, *Semicond. Int.* (1980).
- [169] K.C. Yung, K.C. Chan, T.M. Yue, K.F. Yeung, *Int. J. Adv. Manuf. Technol.* 23 (2004) 245.